

AVAILABLE OPTIONS FOR TANKS:

1. PLASTIC PIPE SEALS OR BOOTS PROVIDED AT PIPE OPENINGS.
2. EFFLUENT FILTERS CAN BE PROVIDED AS REQUIRED, BUT INSTALLED BY OTHERS.
3. CAST IN PVC RISERS WITH COVERS WITH SAFETY GRATES IF REQUIRED.
4. 24" DIA., 36" DIA. & 48" DIA. PRECAST CONCRETE RISERS AND ADJUSTING RINGS.
5. SQUARE AND RECTANGULAR PRECAST CONCRETE RISERS.
6. CAST IRON FRAMES & COVERS
7. ALUMINUM HATCHES
8. CUSTOM PIPE OPENING AND ACCESS OPENING SIZES & LOCATIONS.
9. CUSTOM INTERIOR PRECAST WALLS.
10. POLYPROPYLENE COATED STEEL STEPS.
11. COAL TAR EPOXY INTERIOR COATED.
12. BITUMINOUS TAR EXTERIOR COATED.

SEPTIC TANK NOTES:

1. ALL TANK DIMENSIONS ARE IN INCHES.
2. ACCESS OPENINGS PROVIDED PER PLAN. DETAIL SHOWS STANDARD OPENINGS.
3. TANK JOINT SEALED WITH BUTYL SEAL ASTM C-990-91.
4. TANKS ARE ASTM C-1227.
5. GRADE 65 WIRE.
6. GRADE 60 REBAR.
7. OUTLET SIPHON PROVIDED, BUT INSTALLED BY CONTRACTOR. SIPHONES FOR GREASE AND OIL SEPERATORS ARE PROVIDED BY OTHERS

WEIGHT:

TOP - 4,497 LBS.
 BOTTOM - 4,497 LBS.
 TOTAL - 8,995 LBS.

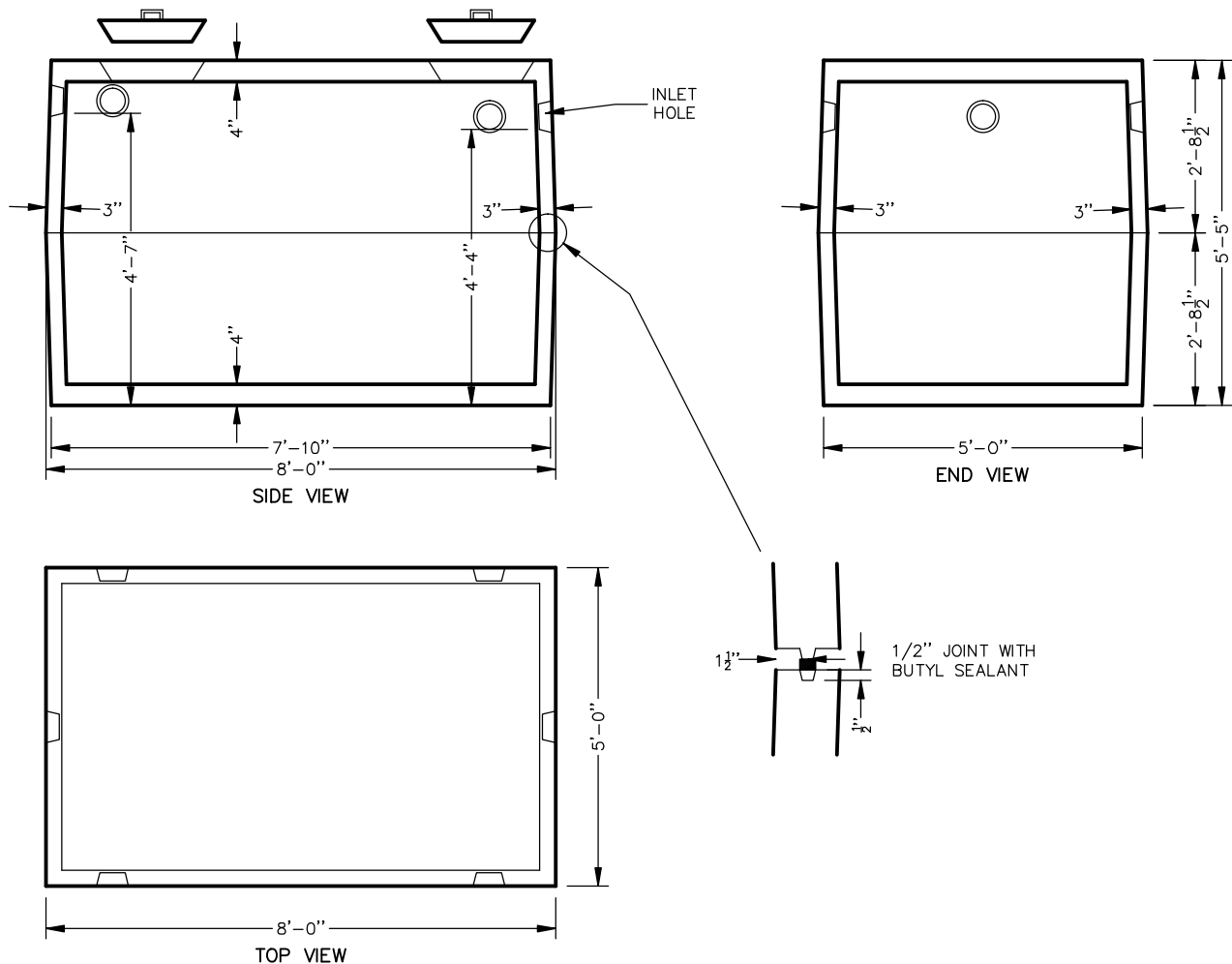

1000 GALLON SEPTIC TANK



FILE NO.: 151122E

DATE: 05/02/2015 PG# 38

O: 616.453.9429
 F: 616.453.7580
 2500 3 MILE ROAD NW
 GRAND RAPIDS, MI 49534-1314
 www.grandvalleyconcrete.com